



**Glo-Ball C2 (Halogen) - Specification Sheet**  
 by Jasper Morrison, 1998

Mounting	Ceiling
Lamp (Bulb) Description	1 x 150W T-8 Medium Frosted Halogen (Included)
Canopy Dimension	Diameter 5.7"
Environment	Indoor - Dry Location
Dimming	Phase-cut Dimming / Triac Type
Finish	Opal
Technical and Product Description	GLO-BALL C2 ceiling-mounted fixture providing diffused light. Diffuser consisting of an externally acid-etched, hand blown, opaline glass and of a die-cast aluminum threaded ring nut with alodine plating finish. A 30% fiberglass reinforced injection-molded polyamide ceiling fitting; gray painted die-cast aluminum diffuser support.

**Electrical**

Voltage	120
IP Rating	IP40

**Physical**

Construction Material	Glass
Weight	8.8 lbs



 FU302800 Opal

**Dimensional Image**

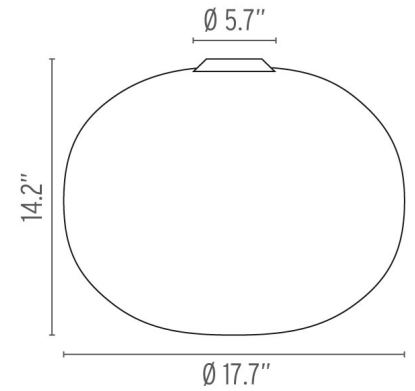

**Certifications**



**Lamping (Bulb)**



150W T8 E26 Frosted Halogen

**Lamping (Bulb)**



RF34655 PRO-T38LED 14W 120V E26 2700K  
 DIMM - 1800lm - CRI80 Additional

**Lamping (Bulb)**



RF35739 PRO-T38LED 14W 120V E26 3000K  
 Dimmable - 1800lm - CRI80- Additional